

Design of solar cell antenna (SOLAN) in different AgHT-8 patch shape for reflection co-efficient, gain, power and directivity compared with existing AgHT-4 and ITO

A.Suresh Kumar, S.Sundaravadivelu

Abstract— Solar cell antenna is a combination of Solar cell and Microstrip antenna. SOLAN design is mainly used in autonomous property for transceiver. RF and Optic are the two intelligence components used to design the SOLAN. It generates DC power supply when light falls on the surface of AgHT-8 and penetrates towards the solar cell. Similarly EM wave falls on the surface of AgHT-8 and produce RF signal. By using SOLAN we can calculate reflection co- efficient, gain and power for different shapes, size and design when compared with existing AgHT-4 and ITO.

Index Terms— Solar cell antenna (SOLAN), AgHT-4, AgHT-8, ITO, ADS, transceiver, hybrid.

I. INTRODUCTION

Solar cell antenna is used in different application such as environmental monitoring system, vehicular communication and Satellite systems. SOLAN is used in satellite communication [1], metal plate of solar supports UMTS Pico- cell base station[2], mesh patch antenna and circular grid antenna are used for car wind shields[3-5], optically transparent wide band antenna supports communication system[6- 12], SOLAN array antenna power is more due to RF and Optic intelligence[13].

II. Similarity between Antenna and Solar Cell

Compare with Microstrip antenna and solar cell, ground plate, coaxial port, subtract are similar. In upper

part of the solar cell, silicon wafer is used for light reception and in microstrip antenna metallic plate is used for receiving EM waves. In SOLAN design, the solar cell is placed under the microstrip antenna. A transparent conducted coated film (AgHT-8) is placed in microstrip antenna for penetrating light towards the solar cell. It generates both DC supply and RF wave due to falling of light and EM wave shown in figure2.

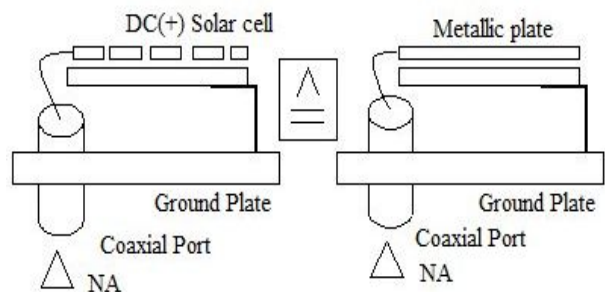

Figure1 Similarity between Micro strip antenna and solar cell

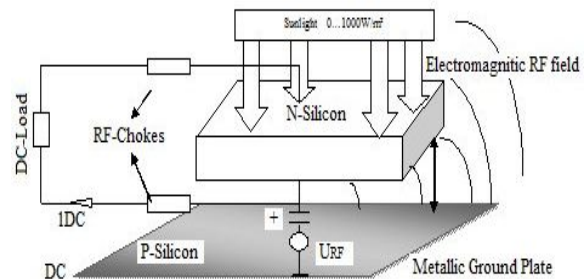

Figure 2 SOLAN Radiation of electromagnetic waves and direct current generation

III. Equivalent circuit of SOLAN

Solar cell equivalent circuit is specially simulated in electronic work bench for measuring power (P), current (I) and voltage (V). Microstrip antenna equivalent circuit are separately simulated and the same output is measured. Finally both microstrip and solar cell circuits are combined and output is measured. While comparing both outputs, combination of microstrip and solar cell equivalent circuit produces

Manuscript received July 07, 2014

A.Suresh Kumar, Professor and Head, Department of Electronics & Communication Engineering in Pavendar Bharathidasan College of Engineering & Technology, Mathur, Trichy, Tamilnadu, India.

S.Sundaravadivelu, Professor, Department of Electronics & Communication Engineering in SSN Engineering College, Kalavakkam, Chennai, Tamilnadu, India.

Design of solar cell antenna (SOLAN) in different AgHT-8 patch shape for reflection co-efficient, gain, power and directivity compared with existing AgHT-4 and ITO

high voltage (V), current (I) and power (P). The simulation of SOLAN in Electronics work bench provides the following values of current (I) =872.8mA Voltage (V) =8.728mV and Power (P) =7.6177984mW were measured as shown in figure 3.

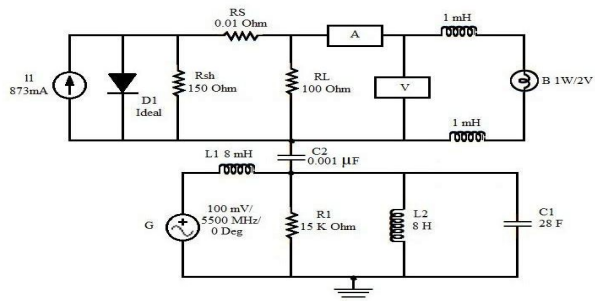

Figure 3 combined equivalent circuit of solar cell and microstrip antenna

IV. Solar cell integration with microstrip antenna for different AgHT-8 patch shape

The common equation used to design the AgHT-8 patch antenna dielectric layer is called Perspex and the equations depends on patch length(L), width(W), substrate height(h), frequency(f) and also length(Lst) and width(Wst) of the Microstrip are designed from following equations.

$$L=0.49\lambda_0/\epsilon_r$$

For square patch

$$L=W$$

$$\epsilon_{\text{reff}}=(\epsilon_r+1/2)+(\epsilon_r-1/2)[1+12h/w]^{-1/2}$$

$$f=c/2(L+h)\epsilon_{\text{reff}}$$

Width of the Microstrip line

$$W_{\text{st}}=((377/Z_{\text{line}}\epsilon_r)-2)t$$

Length of the strip

$$L_{\text{st}}=\lambda_0/4\epsilon_r$$

For all AgHT-8 patch shape

$$L=19\text{mm}, w=19\text{mm}, \epsilon_r=2.6, h=3\text{mm},$$

$$w_{\text{st}}=1.8\text{mm}, L_{\text{st}}=33\text{mm}, f=1.5\text{ GHz to }5.5\text{GHz}$$

V. Comparison among SOLAN made AgHT-8 patch, AgHT-8 mesh patch, AgHT-8 Hybrid patch with existing AgHT-4 and ITO

A. Reflection co-efficient of all SOLAN

The Reflection co-efficient of the SOLAN integrated with different patch sizes are simulated with ADS and summarized in table 1 with frequency range from 1.5GHz to 5.5GHz. The table clearly shows that the

Hybrid patch provides better reflection co-efficient compared to the remaining listed sizes, reflection co-efficient is low radiation is high which is clearly shown in figure 4.

Frequency (GHz)	AgHT-8 Patch S ₁₁ (dB)	AgHT-8 MESH Patch S ₁₁ (dB)	AgHT-8 HYBRID Patch S ₁₁ (dB)	AgHT-4 Patch S ₁₁ (dB)	ITO Patch S ₁₁ (dB)
1.5	0	0	0	0	0
2	-0.5	-1	-1	-1.5	-0.5
2.5	-2	-2	-3	-2	-2
3	-6	-8	-5	-3	-6
3.5	-3	-4	-4	-8	-4
3.9	-22	-32	-39	-11	-35
4	-23	-19	-14	-3	-10
4.5	-2	-2	-2	-3.5	-2
5	-3	-4	-4	-4	-3
5.5	-10	-10	-10	-3	-10

Table 1 Reflection co-efficient values of AgHT-8 SOLAN in different patch shape with AgHT-4 and ITO

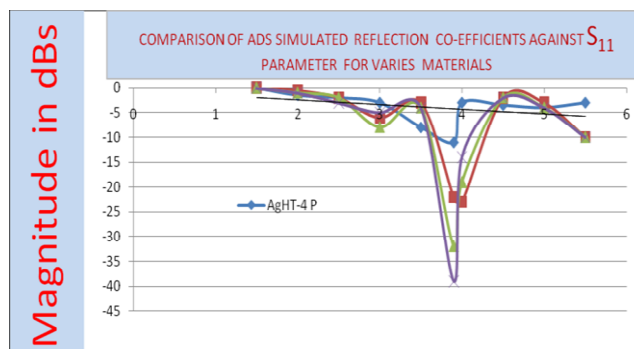

Figure 4 Comparison of reflection co-efficient for different AgHT-8 SOLAN with AgHT-4 and ITO

B. Gain of all SOLAN

The Gain of the SOLAN with different patch size is simulated with ADS is summarized in table 2. It is clearly noted that the Hybrid patch provides better gain compared to the others, gain high signal strength is more and it is shown in the figure5.

AgHT-8 PATCH G(dB)	AgHT-8 MESH PATCH G(dB)	AgHT-8 HYBRID PATCH G(dB)	AgHT-4 PATCH G(dB)	ITO Patch G(dB)
2.21492	2.19715	2.24068	2.16715	2.23976

Table 2 Gain values in dB of SOLAN with different shape AgHT-8 with AgHT-4 and ITO

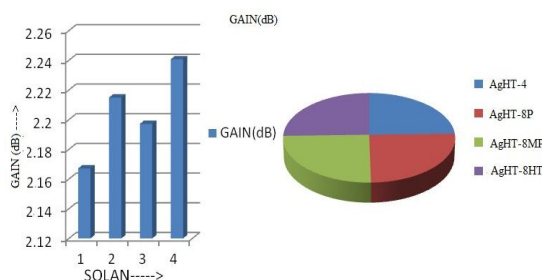

Figure 5 Comparison of Gain for different AgHT-8 SOLAN with AgHT-4 and ITO.

C. Power of all SOLAN

The Power of the SOLAN with different patch size is simulated with ADS are summarized in table 3. It is clearly shows that the Hybrid patch provides better Power compared to the others, Power high signal strength is more and it is shown in the figure 6.

AgHT-8 PATCH P(W)	AgHT-8 MESH PATCH P(W)	AgHT-8 HYBRID PATCH P(W)	AgHT-4 PATCH H P(W)	ITO PATCH H P(W)
0.000027877	0.000027991	0.0000283	0.000026723	0.0000282822

Table 3 Power values in Watt of AgHT-8 SOLAN with different shape Compared with AgHT-4 and ITO.

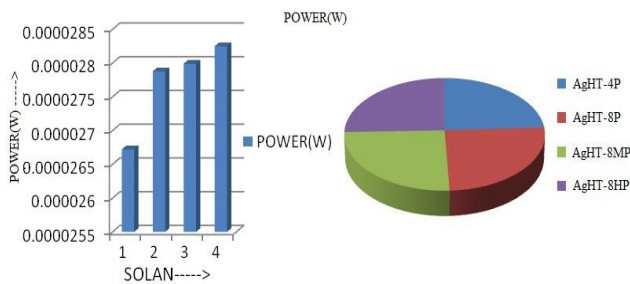

Figure 6 Comparison of Power for different AgHT-8 SOLAN with AgHT-4 and ITO.

D. Directivity of all SOLAN

The Directivity of the SOLAN with different patch size is simulated with ADS are summarized in table 4. It is clearly observed that the Hybrid patch provides better Directivity compared to the others, Directivity high signal strength is more one direction and it is shown in the figure 7.

AgHT-8 PATCH D(dB)	AgHT-8 MESH PATCH D(dB)	AgHT-8 HYBRID PATCH D(dB)	AgHT-4 PATCH D(dB)	ITO PATCH D(dB)
6.65147	6.65163	6.65431	2.53	6.65414

Table 4 Directivity values in dB of AgHT-8 SOLAN different shape Compared with AgHT-4 and ITO.

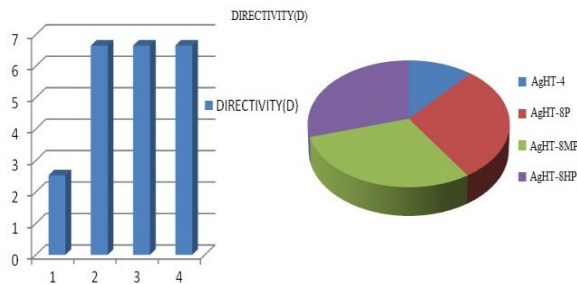

Figure 7 Comparison of Power for different AgHT-8 SOLAN with AgHT-4 and ITO.

E. Model of SOLAN

The SOLAN design was simulated in ADS and its two or three dimensional and real hardware was designed, implemented and tested as shown in Fig.8.

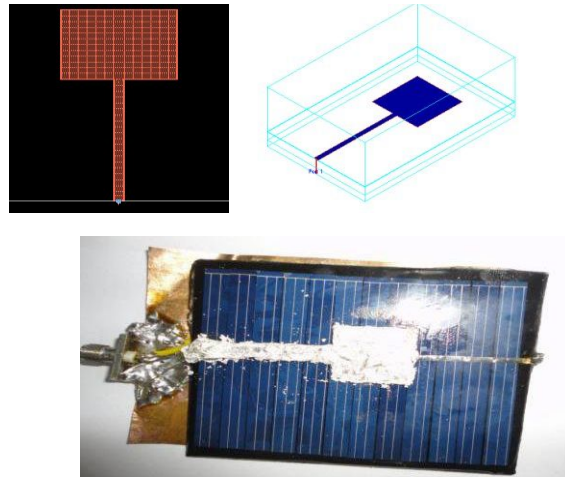

Figure 8 simulated and real model of AgHT-8 patch SOLAN model

VI. comparison of AgHT-4 and ITO with AgHT-8

AgHT is highly conductive coated films and it is used in EM/RF wave. AgHT plays an important role in material science application. AgHT-8 is better than AgHT-4 and ITO because surface resistance of AgHT-8 is high. It produces high reflection co-efficient when compared with AgHT-4 and ITO. Due to high reflection co-efficient, the radiation is high when compared with AgHT-4 and ITO.

VII. Conclusion

The different SOLAN types were simulated using ADS software and the results obtained and compared with existing AgHT-4 and ITO. Among the obtained results the AgHT-8 hybrid patch SOLAN outperforms others, compared to other shapes. Because AgHT-8 hybrid patch has more transparent conducting film. Hence the AgHT-8 hybrid patch SOLAN antenna can be used as basic platform for many communication applications and it can also be used as a transceiver for RF signal and to generate direct current. The resonance frequency of the SOLAN depends on the patch size.

References

1. S. Vaccaro, P. Torres, J. R. Mosig, A. Shah, A. K.Skrivernik, J.-F. Zürcher, P. de Maagt, and L. Gerlach, "Combination of antennas and solar cells for satellite communications," Microwave and Optical Technology Letters, vol. 29, no. 1, pp. 11–16, Apr. 2001.

Design of solar cell antenna (SOLAN) in different AgHT-8 patch shape for reflection co-efficient, gain, power and directivity compared with existing AgHT-4 and ITO

2. S. V. Shynu, M. J. Roo Ons, M. J. Ammann, S. J. McCormack and B. Norton, "A Metal Plate Solar Antenna for UMTS Pico-Cell Base Station", in Proc. Loughborough Antennas & Propagation Conference (LAPC 2008), Loughborough, UK, Mar. 17-18, 2008.
3. G. Clasen and R. Langley, "Meshed patch antennas," IEEE Transactions on Antennas and Propagation, vol. 52, pp. 1412-1416, 2004.
4. G. Clasen and R. Langley, "Meshed patch antenna integrated into car windshield," Electronic Letters, vol. 36, pp. 781-782, 2000
5. G. Clasen and R. Langley, "Gridded circular patch antennas," Microwave and Optical Technology, Letters vol. 21, pp. 311-313, 1999.
6. R. N. Simons and R. Q. Lee, "Optically transparent microstrip patch and slot antennas," US Patent 5872532, 1999.
7. C. Mias, C. Tasakonas, N. Prountzos, D. Koutsogerorgis, S. Liew, C. Oswald, R. Ranson, W. M. Cranton, and C. B. Thomas, "Optically transparent microstrip antennas," in IEEE Colloquium on Antennas forAutomotives, London, UK, Aug. 1-6 2000
8. N. Guan, H. Furuya, D. Delaune, and K. Ito, "Antennas made of transparent conductive films," PIERS online, vol. 4, no. 1, pp. 116-120, 2008.
9. Katsounaros, Y. Hao, N. Collings, and W. Crossland, "Optically transparent ultra- ideband antenna," Electronics Letters, vol. 45, no. 14, pp. 722-723, 2009.
10. T. Peter, R. Nilavalan, "Study on the Performance Deterioration of Flexible UWB Antennas" Loughborough, UK, Antennas & Propagation Conference, 16-17 November 2009.
11. Ahmed Nabih Zaki Rashed, Hamdy A. Sharshar, "Optical Microstrip patch antennas design and analysis" Optik - International Journal for Light and Electron Optics, Volume 124, Issue 20, October 2013, Pages 4331-4335.
12. Linxing Shi, Zhen Zhou, Bingshu Tang, "Optimization of Si solar cell a with full band optical absorption increased in all polarizations using plasmatic back contact grating" Optik - International Journal for Light and Electron Optics, Volume 125, Issue 2, January 2014, Pages 789-794.
13. Okan Yurduseven, David Smith, Nicola Pearsall, Ian Forbes and David Johnston, "A Meshed Multiband Solar Patch Array Antenna" 12-13 November 2012, Loughborough Antennas & Propagation Conference.

Authors' information



Mr. A. Suresh Kumar is working as a Professor and Head, Department of Electronics &

Communication Engineering in Pavendar Bharathidasan College of Engineering & Technology, Mathur, Trichy, Tamilnadu, India. He obtained his Bachelor degree in Electronics and Communication Engineering from Mookambigai College of Engineering, Thirucinapalli and Masters in Communication Systems from Regional Engineering College (N.I.T), Thiruchirappalli, both degrees are from Bharathidasan University and Perusing part time PhD program in Optical sensors in faculty of information and communication at Anna University Chennai. He has 18 years of teaching experience. His areas of interest are Antennas, Television and video Engineering, Satellite communication, Digital signal processing, Optical Communication and Wireless communication. He is currently doing his research in Solar cell Antennas. He has Published 5 Text Books and presented one International Conference paper, 5 National Conference papers and in other areas presented one international conference paper, 5 National Conference papers and published one paper in International Journal. He guided many UG and PG student projects.



Dr. S. Sundaravadivelu is working as a Professor, Department of Electronics & Communication Engineering in SSN Engineering College, Kalavakkam, Chennai, Tamilnadu, India. He obtained his Bachelor degree in Electronics and Communication Engineering from Thiagarajar College of Engineering, Madurai and Masters in Communication Systems from Regional Engineering College, Trichy and Ph.D in CAD of Optical Integrated Circuits from Madurai Kamaraj University. He has 25 years of teaching and research experience. His areas of interest are Optical Communication, Optical MEMS, Optical Signal Processing, Optical Image Processing and Optical Networks. He is currently working in the area of LIDAR Applications. He has guided 5 Ph.D candidates and is currently guiding 6 Ph.D candidates and published papers in 6 International Journals, 5 National Journals, 6 International Conferences and 10 National Conferences.